

Stepped lever on long backplate

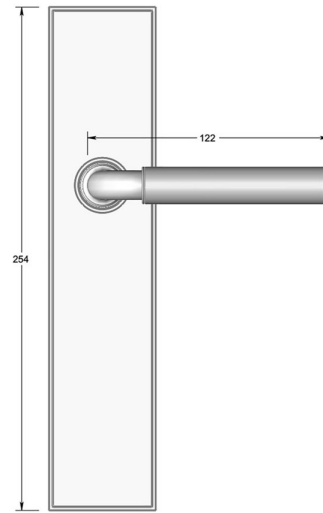

Product image



Dimensions drawing (DIM)

Reference

FL206 TB03 PNI

Material

Brass

Finish

Trad polished nickel

Shape

TB03

Description

Solid cast handle
 Concealed fixing
 High performance bearing
 Supplied with fixings for timber
 Available with various backplates and roses